



Hrvatsko asfaltno društvo

Croatian asphalt association

Zadaće i inicijative Europske asocijacije za
asfaltno kolničenje

*Tasks and Initiatives of the European Asphalt
Pavement Association*

Dr. Carsten Karcher

European Asphalt Pavement Association

Međunarodni seminar ASFALJNI KOLNICI 2018
International seminar ASPHALT PAVEMENTS 2018

Opatija, 12.–13. 04. 2018.

EAPA



- ▶ EAPA is a non-profit association, founded in 1973 and nowadays based in Brussels, Belgium
- ▶ EAPA represents the majority of the European asphalt paving industry
 - ▶ The manufacturers of asphalt and asphalt paving companies
 - ▶ Material and equipment suppliers
- ▶ EAPA's mission
 - ▶ To promote the good use of asphalt and the maintenance of a sustainable European road network



OFFICIALS



John Kruse Larsen
President



Christoph Hagemeyer
Vice-President



Egbert Beuving
Secretary General



Dr. Carsten Karcher
Director

















MEMBERS



▶ 15 National Associations

- ▶ Croatia
- ▶ Czech Republic
- ▶ Denmark
- ▶ Estonia
- ▶ Finland
- ▶ France
- ▶ Germany
- ▶ Hungary
- ▶ Ireland
- ▶ Norway
- ▶ Slovenia
- ▶ Spain
- ▶ Sweden
- ▶ Turkey
- ▶ United Kingdom

MEMBERS

 Asefma	 Asfaltindustrien	 ASMUD - Turkish Asphalt Contractors Association	 DAV - Deutscher Asphalt Verband e.V.	 EBA	 Eesti Asfaldiliit
 HAPA - Hungarian Asphalt Pavement Association	 IAPA - Irish Asphalt Pavement Association	 Infra Contractors' Association	 MPA - Mineral Products Association	 NCC AB	 Peab Asphalt AB
 Sdruzeni pro vystavbu silnic Praha	 USIRF - Routes de France	 Zdruzenje asfalterjev Slovenije	 HAD		

MEMBERS

▶ 25 Material and Equipment Suppliers



 ABZ-1 ABZ-1	 AMMANN Ammann Group	 Antico INTERNATIONAL INC. Antigo - MHB Breakers Ltd.	 ASTEC INDUSTRIES, INC. ASTEC	 BENNINGHOVEN Benninghoven	 BTC Chemical Distribution BTC Europe GmbH	 CATERPILLAR Caterpillar Paving Products Inc.
 CFF CFF	 CRH CRH plc.	 DU PONT DuPont CZ s.r.o.	 genan Knowledge based Recycling Concepts Genan	 Honeywell Honeywell	 ICL Performance Products ICL Performance Products LP	 Ingevity Ingevity
 JRS J. Rettenmaier & Söhne GmbH & Co	 KRATON Kraton Polymers Nederland B.V.	 MARINI FAYAT GROUP Marini	 ruthmann FIBRES WORLDWIDE Ruthman	 sasol Sasol Wax	 SELENIZZA NATURAL BITUMEN Selenice Bitumini	 Tüpraş Turkish Petroleum Refineries Co.
 Vialit Vialit	 VÖGELE Vögele	 VOLVO Volvo Construction Equipment	 Zydex Zydex			



COMMITTEES

- ▶ Technical Committee (TC)
- ▶ Health, Safety and Environment Committee (HSE)
- ▶ Directors' Group (DG)
- ▶ Executive Committee (ExCo)
- ▶ General Council Assembly (GCA)
- ▶ Asphalt Plant- & Equipment Manufacturers Group (AP&EM)
- ▶ Various Task Groups e.g. Rejuventors
- ▶ Joint Committees with EUROBITUME
- ▶ GAPA Meeting
- ▶ Committees for the E&E Congress and Event (OC, TPC)

OBJECTIVES AND TASKS

- ▶ Participate in European standardisation and legislation activities
- ▶ Represent its members in the institutions of the EU
- ▶ Promote the effective and sustainable use of asphalt and new developments
- ▶ Collect, exchange and promote knowledge as well as best practices
- ▶ Improve the image of “asphalt” in Europe



OBJECTIVES AND TASKS

- ▶ Be reliable partner for Commission and Parliament
- ▶ Translate technical or other details in an easy way to the EC, EP and policymakers
- ▶ Lobbying
 - ▶ Prepare position papers and political statements
 - ▶ Take part in consultations at EU level
 - ▶ Take care of legislation in advance

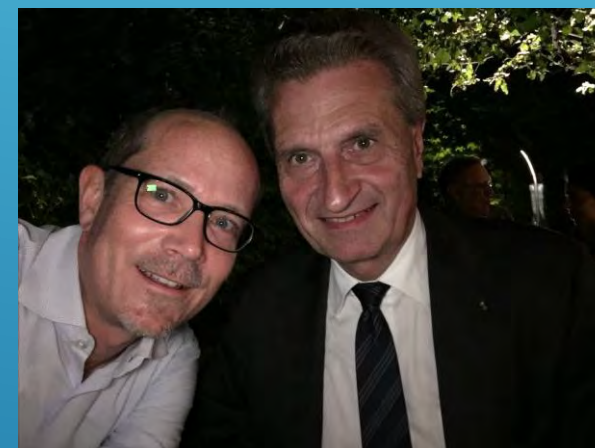

CONTACTS



- ▶ Working together with Europe's like-minded organisations
 - ▶ Eurobitume
 - ▶ European Road Federation (ERF)
 - ▶ Construction Products Europe (CPE)
 - ▶ European Construction Industry Federation (FIEC)
 - ▶ European Aggregates Association (UEPG)
 - ▶ Forum of European National Highway Research Laboratories (FEHRL)
 - ▶ Conference of European Directors of Roads (CEDR)

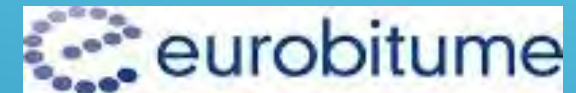

CONTACTS

- ▶ Working together with Europe's like-minded organisations
 - ▶ European Committee for Standardisation (CEN)
 - ▶ European Construction Forum (ECF)
 - ▶ European Road Transport Research Advisory Council (ERTRAC)
 - ▶ European Council for Construction Research, Development and Innovation (ECCREDI)
 - ▶ European Automobile Manufacturers' Association (ACEA)
 - ▶ Committee for European Construction Equipment (CECE)



CONTACTS



- ▶ Working together with international associations and organisations
 - ▶ International Union of Laboratories and Experts in Construction Materials, Systems, and Structures (RILEM)
 - ▶ World Road Association (PIARC)
 - ▶ National Asphalt Pavement Association (NAPA), USA



CONTACTS



- ▶ Working together with Europe's policy makers
 - ▶ European Parliament, Members of European Parliament, Members of the Transport and Tourism Committee, etc.
 - ▶ European Commission, e.g. Directorate-General (DGs)
 - ▶ Mobility and Transport (DG MOVE)
 - ▶ Environment (DG ENV)
 - ▶ Growth (DG Growth)



CONTACTS

- ▶ Global Asphalt Pavement Alliance (GAPA)
 - ▶ AAPA, Australia
 - ▶ JRCA, Japan
 - ▶ Sabita, South Africa
 - ▶ NAPA, USA
 - ▶ Civil Contractors New Zealand Inc.
 - ▶ AMAAC, Mexican Asphalt Association



June 2014: GAPA Meeting in Paris

CONTACTS



- ▶ **Global Asphalt Pavement Alliance (GAPA)**
 - ▶ a forum to discuss issues of common concern
 - ▶ to strengthen the co-operation of asphalt pavement associations across the world
 - ▶ to develop strategies to take on the challenges for the asphalt industry in the future
 - ▶ Egbert Beuving (EAPA) Chairman (since 2013)

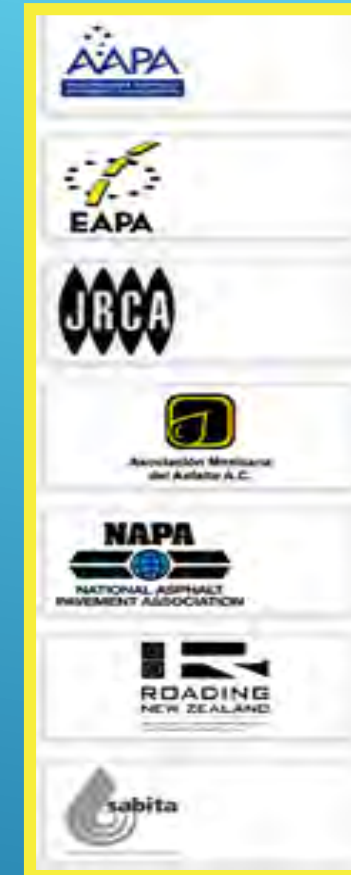

ACTIVITIES AND INITIATIVES

- ▶ Meetings with Members of European Parliament (MEP)
 - ▶ Working dinner with MEP Ismail Ertug in June 2014
 - ▶ Meetings with MEP Dieter Koch, Ismail Ertug and Wim van de Camp of the European Parliament TRAN Committee in 2015
 - ▶ Parliamentary Breakfast Debate together with UEPG and MEP Wim van de Camp and Ismail Ertug in 2016
 - ▶ MEP Meeting on 17 Oct. 2017 “Reducing CO₂ in Transport Sector”



ACTIVITIES AND INITIATIVES

- ▶ Meetings with Members of European Commission (EC)
 - ▶ DG CLIMA with Director General Delbeke and his services in June 2017
 - ▶ DG Research with Advisor William Bird in July 2017
 - ▶ DG MOVE with Director General Hololei and his services in September 2017
 - ▶ Planning of a meeting with DG Enterprise



ACTIVITIES AND INITIATIVES

- ▶ Preparing EU-Items
 - ▶ Green Public Procurement
 - ▶ Waste Framework Directive
 - ▶ Circular Economy
 - ▶ Reducing CO₂ in transport sector



ACTIVITIES AND INITIATIVES



- ▶ Preparing EU-Items
 - ▶ Green Public Procurement
 - ▶ Waste Framework Directive
 - ▶ Circular Economy
 - ▶ Reducing CO₂ in transport sector



ROAD PAVEMENT INDUSTRIES HIGHLIGHT HUGE CO₂ SAVINGS OFFERED BY MAINTAINING AND UPGRADING ROADS

Almost 28 million tonnes of CO₂ from road transport could be saved yearly – let's not waste this opportunity!

EAPA
EUROPEAN ASPHALT PAVEMENT ASSOCIATION
www.eapa.org

EUPAVE
www.eupave.eu

FEHRL
www.fehrl.org

The graphic shows a perspective view of a road with a dashed white center line. On either side of the road, there are stylized green clouds. The clouds on the left side are larger and more numerous, while the clouds on the right side are smaller and fewer, illustrating the reduction in CO2 emissions through road maintenance and upgrading.

More information on www.eapa.org

ACTIVITIES

- ▶ EAPA Health, Safety and Environment Committee (1)
 - ▶ Use of waste in asphalt
 - ▶ Warm Mix Asphalt
 - ▶ Silica Dust/Asbestos
 - ▶ Road Worker Safety
 - ▶ Bitumen Fumes and Aerosols

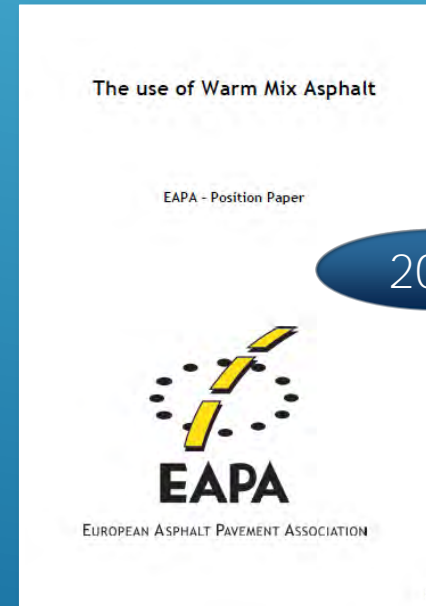
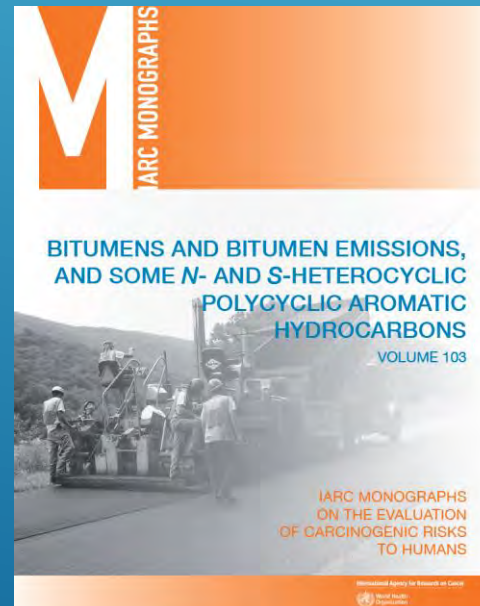
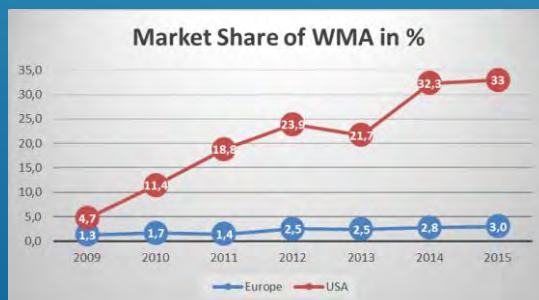
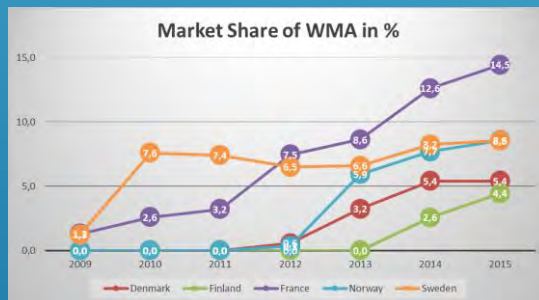

2014

ACTIVITIES

- ▶ EAPA Health, Safety and Environment Committee (2)
 - ▶ Carbon Footprint Document/Environmental Product Declaration (EPD)
 - ▶ Green Public Procurement (GPP)
 - ▶ CO₂-Emissions reduction/Rolling Resistance
 - ▶ Noise Reduction/Noise Directive
 - ▶ Circular Economy

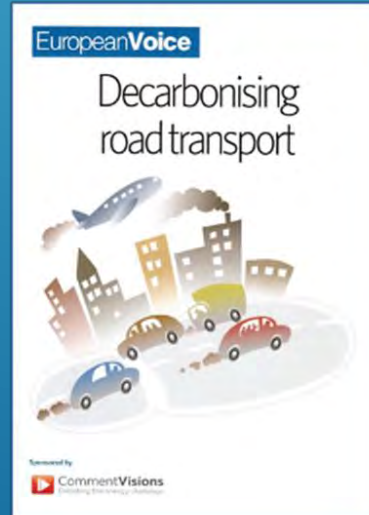
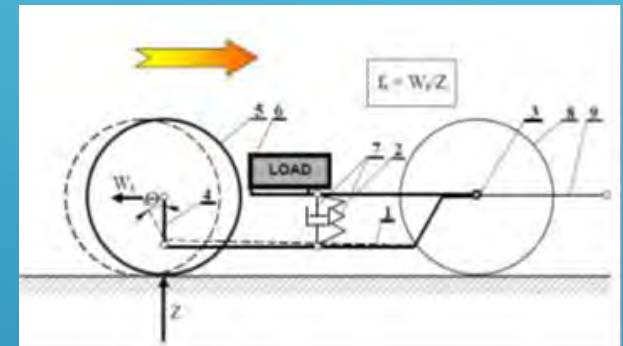

ACTIVITIES



- ▶ EAPA Technical Committee
 - ▶ European Standardisation
 - ▶ Second-generation asphalt standards
 - ▶ New test methods / standards for bitumen (for improving the durability)
 - ▶ Connection e.g. to CEN TC 227/WG1 & 336/WG1
 - ▶ Asphalt Recycling / Rejuvenators
 - ▶ Warm Mix Asphalt

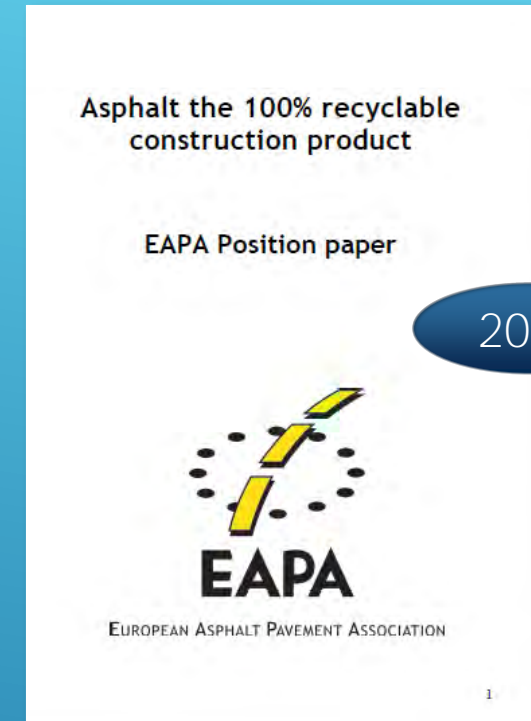

ACTIVITIES

- ▶ EAPA Asphalt Plant- & Equipment Manufacturers Group
 - ▶ Asphalt plant automated Factory Production Control
 - ▶ Use of IT equipment to improve the quality and to assist the workers
 - ▶ Education and attracting new workers / the young generation
 - ▶ Daily Work Control

Source: CECE

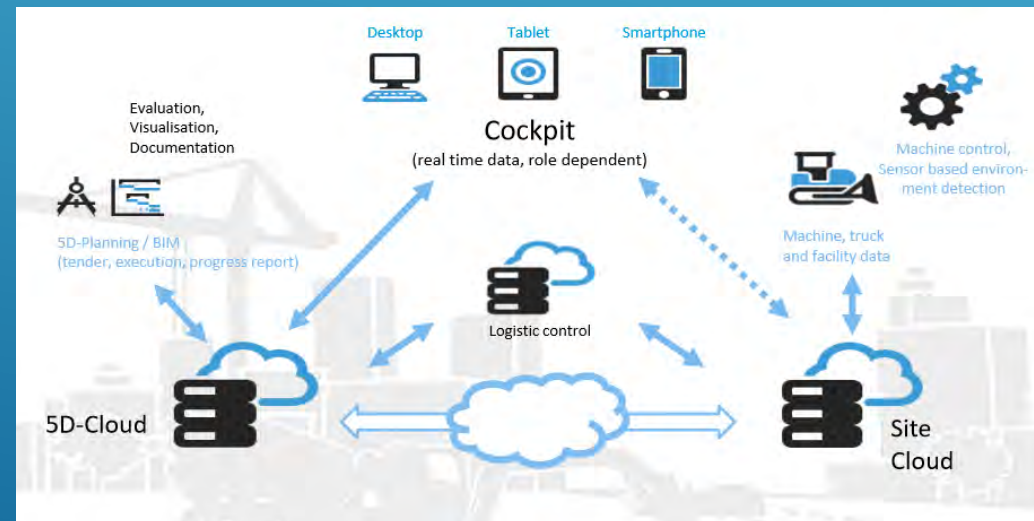

ACTIVITIES

- ▶ Joint EAPA&Eurobitume campaign Asphalt Advantages
 - ▶ Communication plan
 - ▶ Support the Asphalt Market by increasing the current level of awareness and understanding of the benefits of Asphalt to key audiences
 - ▶ Change audiences from 'uninformed' to 'well informed' by providing credible argumentations for their decision-making process

www.AsphaltAdvantages.com

Asphalt. ADVANTAGES



ACTIVITIES



English | Deutsch | Français | Slovensko | Türkçe

Asphalt. ADVANTAGES

HOME ABOUT ASPHALT ADVOCATE NEWS CONTACT US

English | Deutsch | Français | Türkçe

ASPHALT ADVANTAGES IS AVAILABLE IN MULTIPLE LANGUAGES.

Learn about the advantages of choosing asphalt. Search for something of interest.

Type a keyword or phrase

SEARCH

Finden Sie mehr über die Vorteile von Asphalt heraus. Suchen Sie nach etwas, das Sie interessiert.

Geben Sie ein Schlüsselwort oder

SUCHE

NACHHALTIGKEIT KOMFORT SICHERHEIT WIRTSCHAFTLICHKEIT

SUSTAINABILITY COMFORT SAFETY ECONOMICS

asphalteu Asphalt and its role in circular economy. Read more: asphaltadvantages.com/en/advantages/... #AsphaltAdvantages pic.twitter.com/B7...

ADVANTAGE 39 ADVANTAGE 04 RECENT ASPHALT NEWS View More >

EAPA's Asphalt Advocate of the Year 2017 Award

Asphalt. ADVANTAGES



#AsphaltAdvantages

EAPA

EUROPEAN ASPHALT PAVEMENT ASSOCIATION

 eurobitume

ACTIVITIES

► Preparing POSITION PAPERS

2017



2017

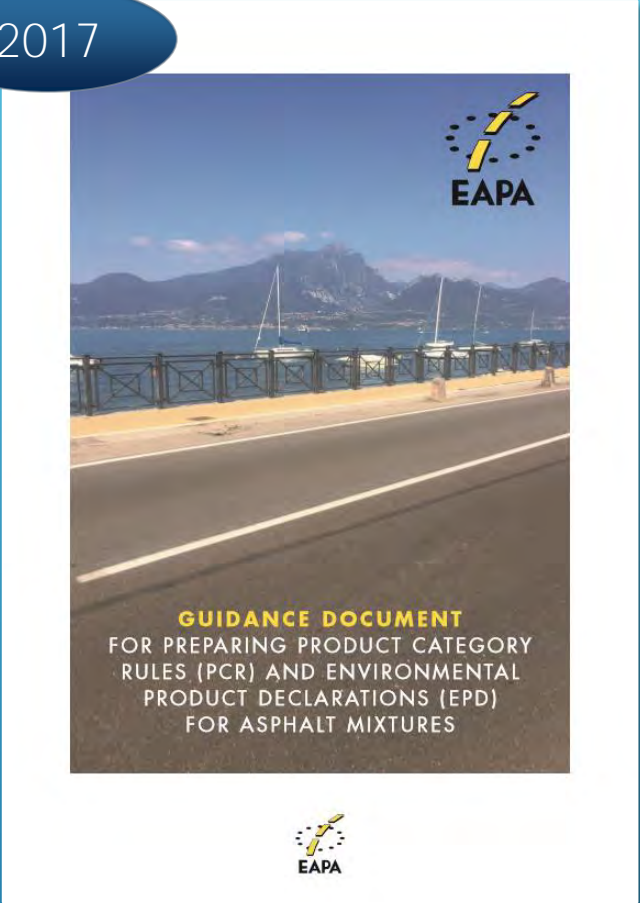
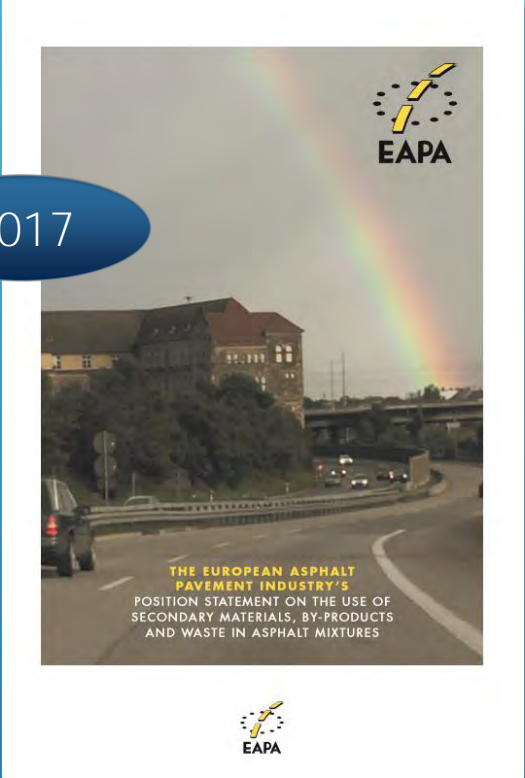

ACTIVITIES

- Contacts
- Information, Data and Statistics
- Advantages of Asphalt Pavements
- News
- Events
- Members Only area



www.eapa.org

ACTIVITIES

- ▶ Asphalt in Figures - Providing Statistical Data on www.eapa.org

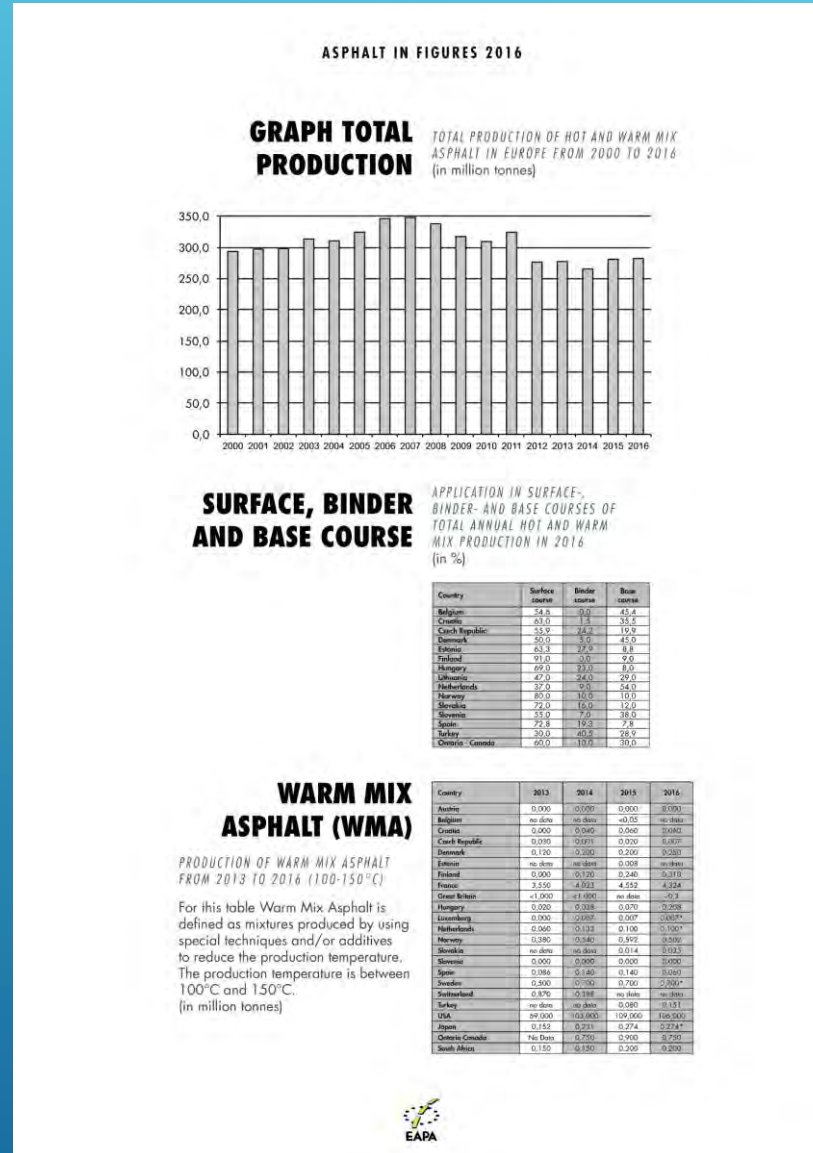

ACTIVITIES



- ▶ Providing a newsletter
 - ▶ Published every 3 - 4 months
 - ▶ Reaches more than 1,200 members and asphalt friends

EAPA MAGAZINE 41 - DECEMBER 2017



EAPA MAGAZINE 41 - DECEMBER 2017

Laurent Porot gave a presentation where he explained the relevancy of the Black Diagram and the Cross-over temperature. This is the temperature where the phase angle δ is 45° . Porot and Jiri Fiedler also explained the Glover-Rowe parameter. This method is a simple method to show the influence of the rejuvenator. The revised EAPA-Paper Heavy Duty Surfaces – the arguments for SMA (as drafted by Bernd Abele) was discussed. The goal is to have this paper approved in June 2018.

There was a short report of the EAPA Asphalt Plant & Equipment Producers Group (AP&EP) activities and the items that were included in the proposed Machine to Machine (M2M) communication protocol were discussed. The EAPA TC also formulated questions for the next AP&EM Group meeting.

Under agenda item CEN TC227 WG6 "Sustainability" Beuving mentioned that the draft Product Category Rules for Bituminous Mixtures were recently sent to CEN TC350 for comments. When the comments of CEN TC 350 have been received the draft will be updated if needed and after that the draft can go out for CEN Enquiry.

Gülşay Malkoç gave a presentation regarding Self-healing asphalt and Breixo Gómez Meijide of the Nottingham Transportation Engineering Centre (NTEC) gave a presentation regarding the Infravation project HEALROAD.

Other technical subjects discussed were:

- Future road requirements – After having discussed this subject it was decided to collect ideas in a small group and to create a structure in the topics mentioned. The results will be discussed in the next EAPA TC meeting.
- Bitumen Quality Characterisation
- The possible need for European Standards for Bitumen additives. The conclusion of the discussion was that there is no need for such standards at this moment but there is a need for a (new) Modified Bitumen Standard blind to modifiers.

The next EAPA TC meeting will be held on 12 April 2018 in Bonn.

12



EAPA MAGAZINE 41 - DECEMBER 2017



EAPA TC meeting



Breixo Gómez Meijide



Meeting of Task Force Rejuvenators



13

ACTIVITIES

► Public Relations

- Interviews
- Editorials
- Presentations
- Publications
- Press releases
- Social Media
- Website



“We need smarter tendering systems”

Dr. Carsten Karcher
Director European Asphalt Pavement Association

There is a massive lack of funding for road maintenance and construction in all European countries. The condition of the road network is getting worse, with decreased safety and comfort as well as higher fuel and maintenance costs for vehicles. A lot of activity is required to keep road conditions at an acceptable service level, although in Eastern Europe the closing of missing links in the road network remains a primary focus.

Further development of the road infrastructure with innovative methods is prevented by traditional tendering systems that favour the lowest price. Initiatives such as the Green Public Procurement System, which takes into account recycling, noise and CO₂ emissions, and the latest procurement directive of the European Commission, which includes life cycle costs, could be important tools to change this.

We need smarter tendering systems that give the road industry the opportunity to display its innovative potential to provide more durable and more environment-friendly asphalt solutions. Allowing the industry to simply carry out the normal maintenance works in the necessary maintenance cycles would lead to much better road surface conditions and would clearly improve the situation for road safety, reducing emissions, user comfort and employment.

New asphalt road surfaces are smooth and even, resulting in reduced noise, rolling resistance, fuel consumption and CO₂ emissions. Tailor-made solutions such as low rolling resistance surfaces and low noise-emitting asphalt pavement systems already exist and if implemented can provide an even greater benefit.” ■

Photo: Anders Roos

Talking point

Three industry experts on the future of the European road network.



INTERVIEW

asphalt im Gespräch mit Carsten Karcher

„Ich möchte positive Schlagzeilen über Asphaltstraßen lesen“

„I'd like to read positive headlines about asphalt pavements“

ACTIVITIES



▶ Organising the Eurasphalt & Eurobitume Congress & Event

- ▶ 5th E&E Congress 2012, Istanbul, Turkey
- ▶ 6th E&E Congress 2016, Prague, Czech Republic
- ▶ **E&E Event, Berlin**, Germany, 14-15 June 2018
- ▶ **7th E&E Congress, Madrid**, Spain
12-14 May 2020



ACTIVITIES



▶ Organising the yearly EAPA Symposium

- ▶ 8th EAPA Symposium, 12 June 2014 in Paris, France
“Challenges and opportunities for the European asphalt paving industry in the 21st century”
- ▶ 9th EAPA Symposium, 3 June 2015 in Istanbul, Turkey “News and solutions from the European asphalt paving industry”
- ▶ 10th EAPA Symposium, 1 June 2017 in Paris, France “Sustainability, Innovation and Communication in the Asphalt Industry”
- ▶ More information on www.eapa.org

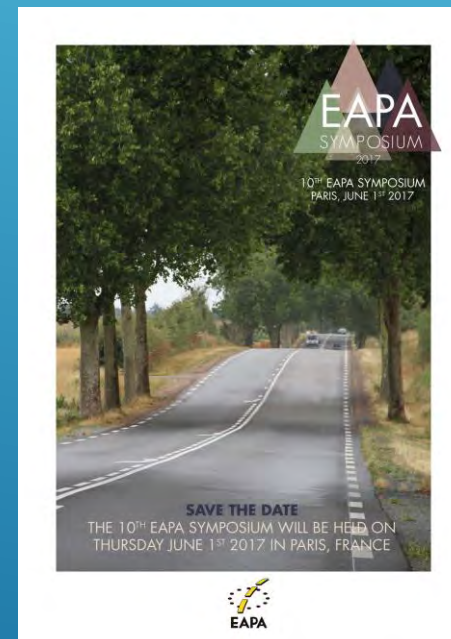

ACTIVITIES

▶ Participating in Research Projects

- ▶ Re-Road, End of Life Strategies of Asphalt Pavement, FP7 project, financed by the European Union
- ▶ Durabroads, Cost-effective DURABLE ROADS by green optimized construction and maintenance, FP7 project, financed by the European Union
- ▶ FunDBitS, Functional Durability-related Bitumen Specification, CEDR project, financed by Conference of European Directors of Roads



SUMMARY

- ▶ Be part of a community to make yourself heard
- ▶ Associations' power = their volunteering members...
Together we are strong!

Coming together is a beginning,
keeping together is progress,
working together is success.

Henry Ford (1863-1947)

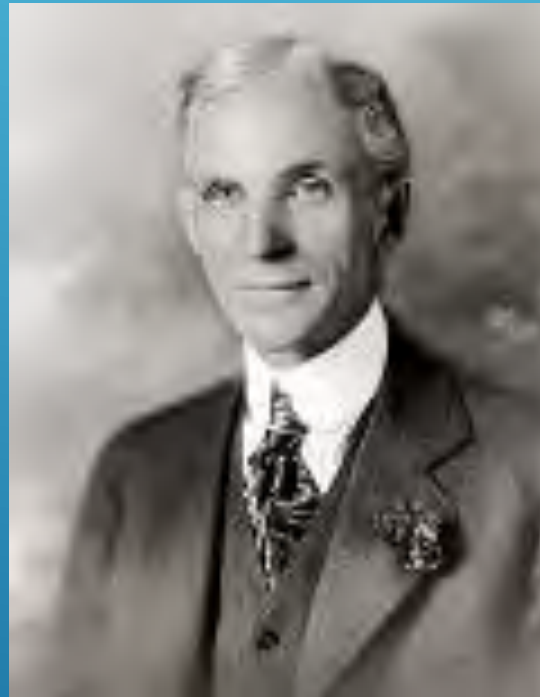

Source: wikipedia

THANK YOU FOR LISTENING!

Dr. Carsten Karcher

website: www.eapa.org
email: karcher@eapa.org
twitter: [@eapa_org](https://twitter.com/eapa_org)
twitter: [@CarstenKarcher](https://twitter.com/CarstenKarcher)

